

成品製造管制圖

DRAWING OF FINISHED PRODUCTS

Type/Pich	1.3 ϕ (<.177" >)
形式 / 間距	4.5mm

禁止使用1級環境管理物質
 Non-use Warranty for Level 1
 Prohibited Substances in Product.

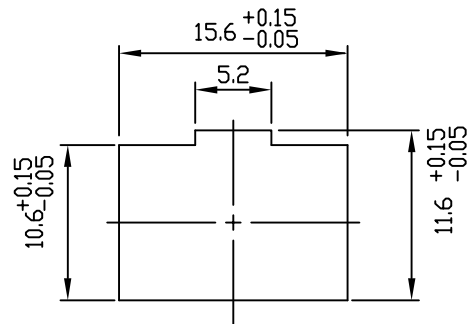
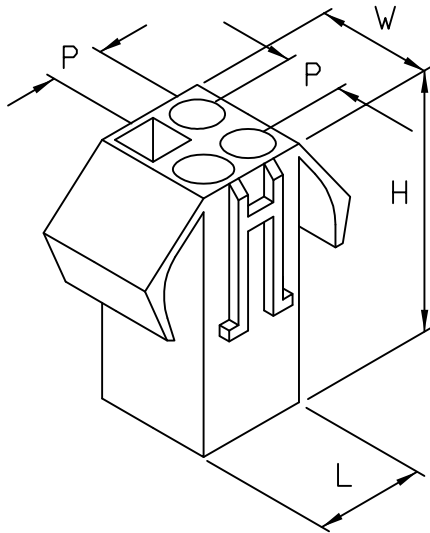

RECOMMENDED PANEL THICKNESS 1.52 MAX

產品編號 Part No: JP1030-4EL
 品名 Product: 塑膠母座 - HOUSING
 材質 Material: Housing: NYLON66 UL94V-0
 配合端子 Suitable Terminal: J1030BS-2EL
 配合塑膠 Suitable housing: JP1130-4EL
 額定電壓/電流 Current Rating:
 AC/DC250V 5A(16~20AWG#)
 絕緣阻抗 INS. Resistance: 1000M Ω Min.
 耐電壓 Withstand Voltage: 1500V AC/1minute.
 適用溫度 Operation Temp: -25°C~+85°C
 顏色 Colour: 本色 (Natural)

DIMENSION:(MM)

P:4.5 \pm 0.1
 L:10.6 \pm 0.2
 W:10.2 \pm 0.2
 H:25.0 \pm 0.3

* 本成品圖僅供參考,若需做為承認用請聯絡就近業務員確認
 (The drawing is for reference only,
 please contact the sales division nearby for final confirmation if it's for approval purpose.)

H/Q: Kaohsiung, Taiwan
 總公司: 高雄, 台灣
 TEL: 886-7-6223787
 FAX: 886-7-6210385
 E-mail: jmt6317@jmt.com.tw

Taipei Branch, Taiwan
 台北營業所
 TEL: 886-2-26940195-7
 FAX: 886-2-26940738
 E-mail: taipei.jmt@msa.hinet.net

Overseas, Taiwan
 外銷業務部
 TEL: 886-7-6223787
 FAX: 886-7-6210385
 E-mail: jmt6318@yahoo.com.tw