

成品製造管制圖

DRAWING OF FINISHED PRODUCTS

禁止使用1級環境管理物質  
 Non-use Warranty for Level 1  
 Prohibited Substances in Product.

Type/Pich	1.58 $\phi$ (.145")
形式/間距	3.68mm

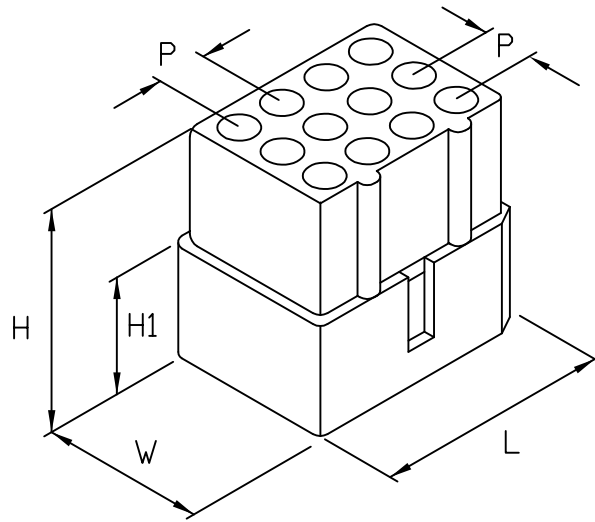

產品編號 Part No: JP1058-12

品名 Product: 塑膠母座 - HOUSING

材質 Material: Housing: NYLON66 UL94V-2

配合端子 Suitable Terminal: J1058BS

配合塑膠 Suitable housing: JP1158-12

額定電壓/電流 Current Rating:

AC/DC250V 8A(18~24AWG#)

絕緣阻抗 INS. Resistance: 1000M  $\Omega$  Min.

耐電壓 Withstand Voltage: 1500V AC/1minute.

適用溫度 Operation Temp: -25°C~+85°C

顏色 Colour: 本色 (Natural)

DIMENSION:(MM)

P:3.68 $\pm$ 0.1

L:18.9 $\pm$ 0.3

W:15.3 $\pm$ 0.3

H:20.0 $\pm$ 0.3

H1:9.2 $\pm$ 0.2

\* 本成品圖僅供參考,若需做為承認用請聯絡就近業務員確認

(The drawing is for reference only,

please contact the sales division nearby for final confirmation if it's for approval purpose.)

H/Q: Kaohsiung, Taiwan

總公司: 高雄, 台灣

TEL: 886-7-6223787

FAX: 886-7-6210385

E-mail: jmt6317@jmt.com.tw

Taipei Branch, Taiwan

台北營業所

TEL: 886-2-26940195-7

FAX: 886-2-26940738

E-mail: taipei.jmt@msa.hinet.net

Overseas, Taiwan

外銷業務部

TEL: 886-7-6223787

FAX: 886-7-6210385

E-mail: jmt6318@yahoo.com.tw