

成品製造管制圖
 DRAWING OF FINISHED PRODUCTS

禁止使用1級環境管理物質
 Non-use Warranty for Level 1
 Prohibited Substances in Product.

Type/Pich	2.36 ϕ (.264")
形式/間距	6.7mm

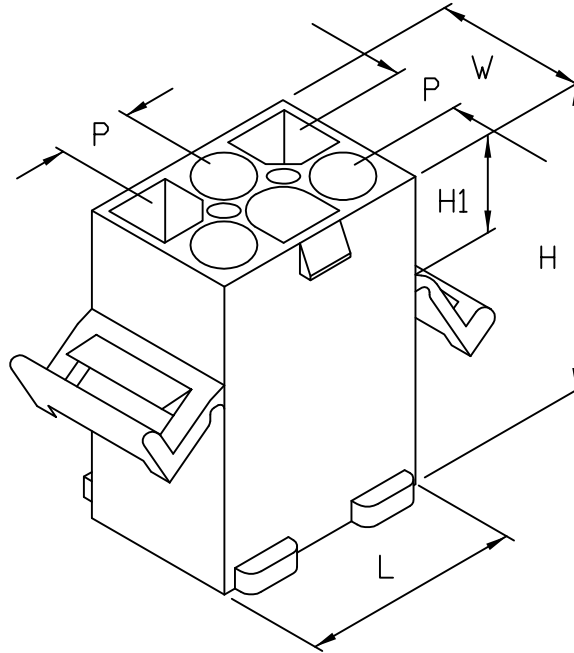

產品編號 Part No: JP2030-6A
 品名 Product: 塑膠母座 - HOUSING
 材質 Material: Housing: NYLON66 UL94V-2
 配合端子 Suitable Terminal: J2030BS/J20301BS
 配合塑膠 Suitable housing: JP2130-6A
 額定電壓/電流 Current Rating:
 AC250V/DC350V 15A(14~18AWG#)
 絕緣阻抗 INS. Resistance: 1000M Ω Min.
 耐電壓 Withstand Voltage: 1500V AC/1minute.
 適用溫度 Operation Temp: -25°C~+85°C
 顏色 Colour: 本色 (Natural)

DIMENSION:(MM)

P:6.7 \pm 0.1
 L:21.7 \pm 0.3
 W:15.0 \pm 0.3
 H:30.2 \pm 0.3
 H1:9.8 \pm 0.3

* 本成品圖僅供參考,若需做為承認用請聯絡就近業務員確認
 (The drawing is for reference only,
 please contact the sales division nearby for final confirmation if it's for approval purpose.)

H/Q: Kaohsiung, Taiwan
 總公司: 高雄, 台灣
 TEL: 886-7-6223787
 FAX: 886-7-6210385
 E-mail: jmt6317@jmt.com.tw

Taipei Branch, Taiwan
 台北營業所
 TEL: 886-2-26940195-7
 FAX: 886-2-26940738
 E-mail: taipei.jmt@msa.hinet.net

Overseas, Taiwan
 外銷業務部
 TEL: 886-7-6223787
 FAX: 886-7-6210385
 E-mail: jmt6318@yahoo.com.tw