

成品製造管制圖  
 DRAWING OF FINISHED PRODUCTS

禁止使用1級環境管理物質  
 Non-use Warranty for Level 1  
 Prohibited Substances in Product.

Type/Pich	2.36 $\phi$ (.198")
形式/間距	5.03mm

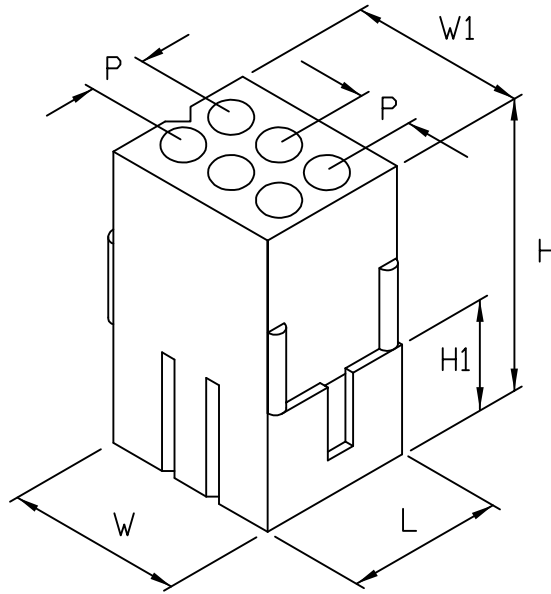

產品編號 Part No: JP2030-6  
 品名 Product: 塑膠母座 - HOUSING  
 材質 Material: Housing: NYLON66 UL94V-2  
 配合端子 Suitable Terminal: J2030BS/J20301BS  
 配合塑膠 Suitable housing: JP2130-6  
 額定電壓/電流 Current Rating:  
 AC250V/DC350V 15A(14~18AWG#)  
 絕緣阻抗 INS. Resistance: 1000M  $\Omega$  Min.  
 耐電壓 Withstand Voltage: 1500V AC/1minute.  
 適用溫度 Operation Temp: -25°C~+85°C  
 顏色 Colour: 本色 (Natural)

DIMENSION:(MM)

P:5.03  $\pm$  0.1  
 L:13.6  $\pm$  0.2  
 W:18.6  $\pm$  0.3  
 W1:16.0  $\pm$  0.2  
 H:24.4  $\pm$  0.3  
 H1:10.6  $\pm$  0.2

\* 本成品圖僅供參考,若需做為承認用請聯絡就近業務員確認  
 (The drawing is for reference only,  
 please contact the sales division nearby for final confirmation if it's for approval purpose.)

H/Q: Kaohsiung, Taiwan  
 總公司: 高雄, 台灣  
 TEL: 886-7-6223787  
 FAX: 886-7-6210385  
 E-mail: jmt6317@jmt.com.tw

Taipei Branch, Taiwan  
 台北營業所  
 TEL: 886-2-26940195-7  
 FAX: 886-2-26940738  
 E-mail: taipei.jmt@msa.hinet.net

Overseas, Taiwan  
 外銷業務部  
 TEL: 886-7-6223787  
 FAX: 886-7-6210385  
 E-mail: jmt6318@yahoo.com.tw