

成品製造管制圖

DRAWING OF FINISHED PRODUCTS

禁止使用1級環境管理物質
 Non-use Warranty for Level 1
 Prohibited Substances in Product.

Type/Pich	2.36 ϕ (.198")
形式/間距	5.03mm

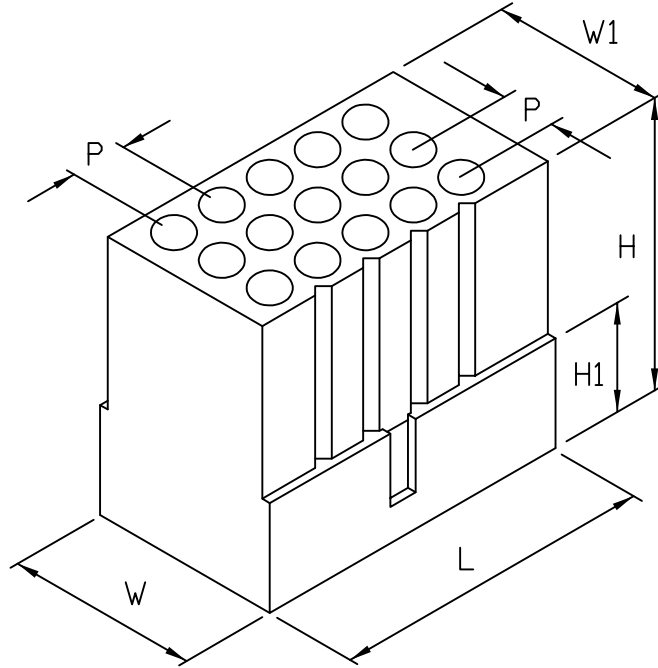

產品編號 Part No: JP2030-15

品名 Product: 塑膠母座 - HOUSING

材質 Material: Housing: NYLON66 UL94V-2

配合端子 Suitable Terminal: J2030BS/J20301BS

配合塑膠 Suitable housing: JP2130-15

額定電壓/電流 Current Rating:

AC250V/DC350V 15A(14~18AWG#)

絕緣阻抗 INS. Resistance: 1000M Ω Min.

耐電壓 Withstand Voltage: 1500V AC/1minute.

適用溫度 Operation Temp: -25°C~+85°C

顏色 Colour: 本色 (Natural)

DIMENSION:(MM)

P:5.03 \pm 0.1

L:30.0 \pm 0.3

W:18.8 \pm 0.2

W1:16.3 \pm 0.2

H:24.6 \pm 0.3

H1:10.8 \pm 0.2

* 本成品圖僅供參考,若需做為承認用請聯絡就近業務員確認

(The drawing is for reference only,

please contact the sales division nearby for final confirmation if it's for approval purpose.)

H/Q: Kaohsiung, Taiwan

總公司: 高雄, 台灣

TEL: 886-7-6223787

FAX: 886-7-6210385

E-mail: jmt6317@jmt.com.tw

Taipei Branch, Taiwan

台北營業所

TEL: 886-2-26940195-7

FAX: 886-2-26940738

E-mail: taipei.jmt@msa.hinet.net

Overseas, Taiwan

外銷業務部

TEL: 886-7-6223787

FAX: 886-7-6210385

E-mail: jmt6318@yahoo.com.tw