

成品製造管制圖

DRAWING OF FINISHED PRODUCTS

禁止使用1級環境管理物質
 Non-use Warranty for Level 1
 Prohibited Substances in Product.

Type/Pich FAST-Terminal
 形式/間距 快接端子110

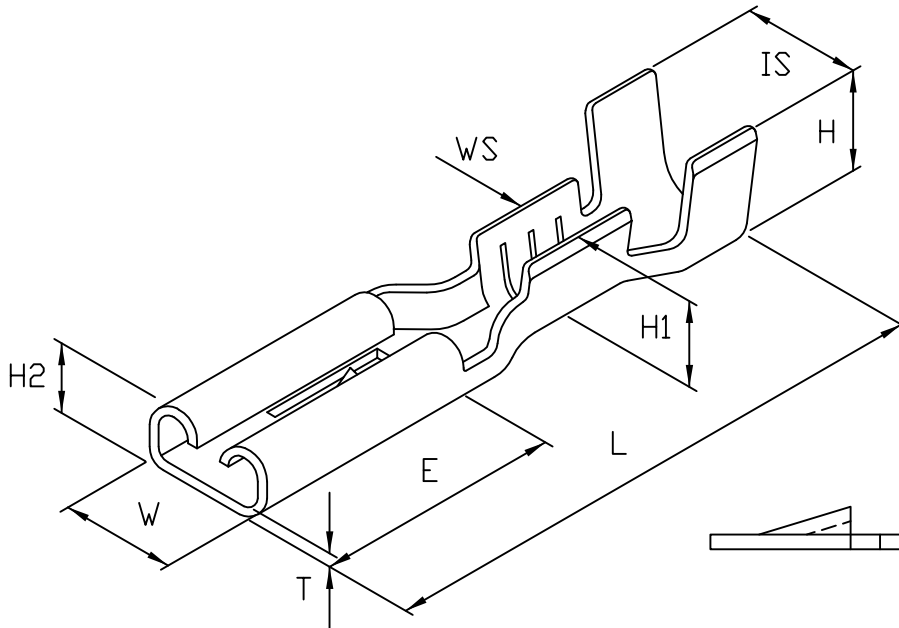

產品編號 Part No: J1730BS

品名 Product: 端子 TERMINAL

材質 Material: Brass

材料厚度 Thickness: 0.25mm

包裝數量 Standard Packing: 10000PCS

適用電線 Suitable Wire: 16~22AWG

表面處理, Treatment: -0 無表面處理, -00 鍍金, -1 鍍鎳, -2 鍍錫

A 先沖後鍍

(-0 Non surface treatment

, -00 Gold flash, -1 Nickel played, -2 Tin plated,

A: PUNCHED AFTER STAMPED TIN)

配合端子 Suitable Terminal: 0.5x2.75 THICKNESS PIN

DIMENSION:(MM)

T:0.25±0.03

L:15.6±0.35

E:6.4±0.25

W:3.75±0.2

IS:3.75±0.3

WS:2.4±0.3

H:4.0±0.3

H1:2.8±0.25

H2:1.85±0.15

* 本成品圖僅供參考, 若需做為承認用請聯絡就近業務員確認

(The drawing is for reference only,

please contact the sales division nearby for final confirmation if it's for approval purpose.)

H/Q: Kaohsiung, Taiwan

總公司: 高雄, 台灣

TEL: 886-7-6223787

FAX: 886-7-6210385

E-mail: jmt6317@jmt.com.tw

Taipei Branch, Taiwan

台北營業所

TEL: 886-2-26940195-7

FAX: 886-2-26940738

E-mail: taipei.jmt@msa.hinet.net

Overseas, Taiwan

外銷業務部

TEL: 886-7-6223787

FAX: 886-7-6210385

E-mail: jmt6318@yahoo.com.tw