

成品製造管制圖
 DRAWING OF FINISHED PRODUCTS

禁止使用1級環境管理物質
 Non-use Warranty for Level 1
 Prohibited Substances in Product.

Type/Pich 形式/間距	Spade Terminal Y 形端子
--------------------	-------------------------

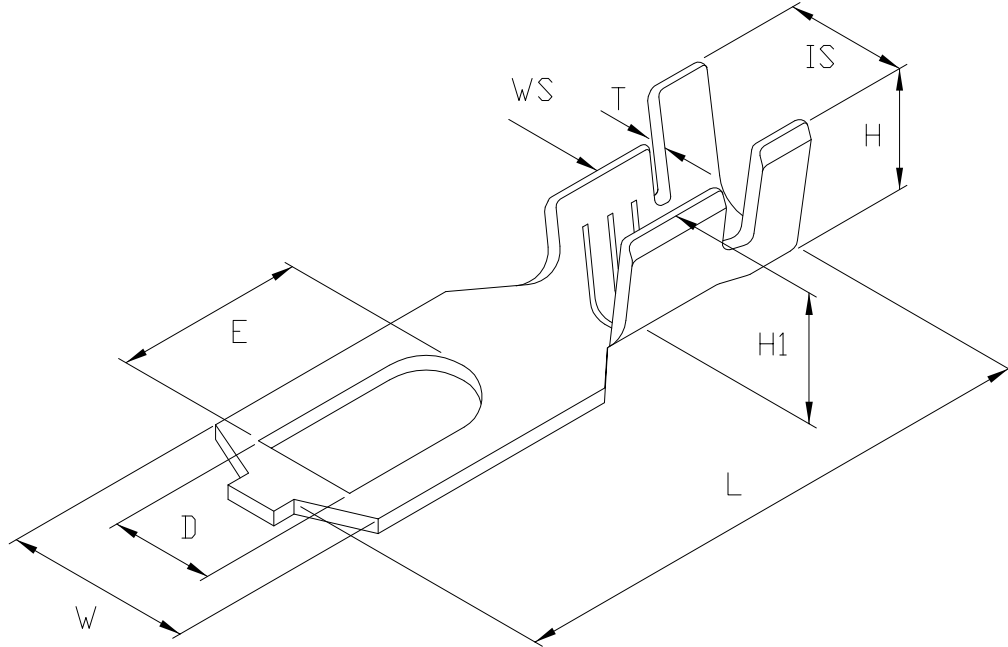

產品編號 Part No: J15351BS

品名 Product: 端子 TERMINAL

材質 Material: Brass

材料厚度 Thickness: 0.5mm

包裝數量 Standard Packing: 7500PCS

適用電線 Suitable Wire: 16~22AWG

表面處理, Treatment: -0 無表面處理, -00 鍍金, -1 鍍鎳, -2 鍍錫

A 先沖後鍍

(-0 Non surface treatment

, -00 Gold flash, -1 Nickel played, -2 Tin plated,

A: PUNCHED AFTER STAMPED TIN)

DIMENSION:(MM)

T:0.5 ± 0.03

L:19.0 ± 0.35

E:6.6 ± 0.25

D:3.7 ± 0.15

W:6.3 ± 0.2

IS:5.0 ± 0.3

WS:3.5 ± 0.3

H:4.4 ± 0.25

H1:3.3 ± 0.25

* 本成品圖僅供參考, 若需做為承認用請聯絡就近業務員確認

(The drawing is for reference only,

please contact the sales division nearby for final confirmation if it's for approval purpose.)

H/Q: Kaohsiung, Taiwan

總公司: 高雄, 台灣

TEL: 886-7-6223787

FAX: 886-7-6210385

E-mail: jmt6317@jmt.com.tw

Taipei Branch, Taiwan

台北營業所

TEL: 886-2-26940195-7

FAX: 886-2-26940738

E-mail: taipei.jmt@msa.hinet.net

Overseas, Taiwan

外銷業務部

TEL: 886-7-6223787

FAX: 886-7-6210385

E-mail: jmt6318@yahoo.com.tw