

成品製造管制圖
 DRAWING OF FINISHED PRODUCTS

禁止使用1級環境管理物質
 Non-use Warranty for Level 1
 Prohibited Substances in Product.

Pich 3.0mm
 間距 (.118")

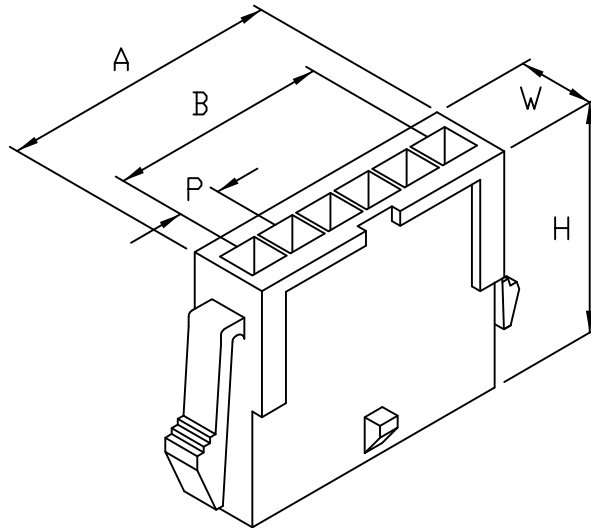

產品編號 Part No: JP2306-1x
 品名 Product: 塑膠母座 - HOUSING
 材質 Material: Housing: NYLON66 UL94V-0
 配合端子 Suitable Terminal: J2306PS-2H
 配合塑膠 Suitable housing: JP2316-1x
 額定電壓/電流 Current Rating:
 AC250V/DC350V 3A(20~24AWG#)
 絕緣阻抗 INS. Resistance: 1000MΩ Min.
 耐電壓 Withstand Voltage: 1000V AC/1minute.
 適用溫度 Operation Temp: -25°C~+85°C
 顏色 Colour: 黑色 (BLACK)

DIMENSION:(MM)

P:3.0 ± 0.1
 W:5.2 ± 0.2
 H:17.0 ± 0.3

PIN	A±0.3	B±0.2
1x2	6.9	3.0
1x3	9.9	6.0
1x4	12.9	9.0
1x5	15.9	12.0
1x6	18.9	15.0
1x7	21.9	18.0
1x8	24.9	21.0
1x9	27.9	24.0
1x10	30.9	27.0
1x11	33.9	30.0
1x12	36.9	33.0

* 本成品圖僅供參考,若需做為承認用請聯絡就近業務員確認
 (The drawing is for reference only,
 please contact the sales division nearby for final confirmation if it's for approval purpose.)

H/Q: Kaohsiung, Taiwan
 總公司: 高雄, 台灣
 TEL: 886-7-6223787
 FAX: 886-7-6210385
 E-mail: jmt6317@jmt.com.tw

Taipei Branch, Taiwan
 台北營業所
 TEL: 886-2-26940195-7
 FAX: 886-2-26940738
 E-mail: taipei.jmt@msa.hinet.net

Overseas, Taiwan
 外銷業務部
 TEL: 886-7-6223787
 FAX: 886-7-6210385
 E-mail: jmt6318@yahoo.com.tw