

成品製造管制圖

DRAWING OF FINISHED PRODUCTS

禁止使用1級環境管理物質  
 Non-use Warranty for Level 1  
 Prohibited Substances in Product.

Type/Pich	1.0 $\phi$ (.163")
形式/間距	4.14mm

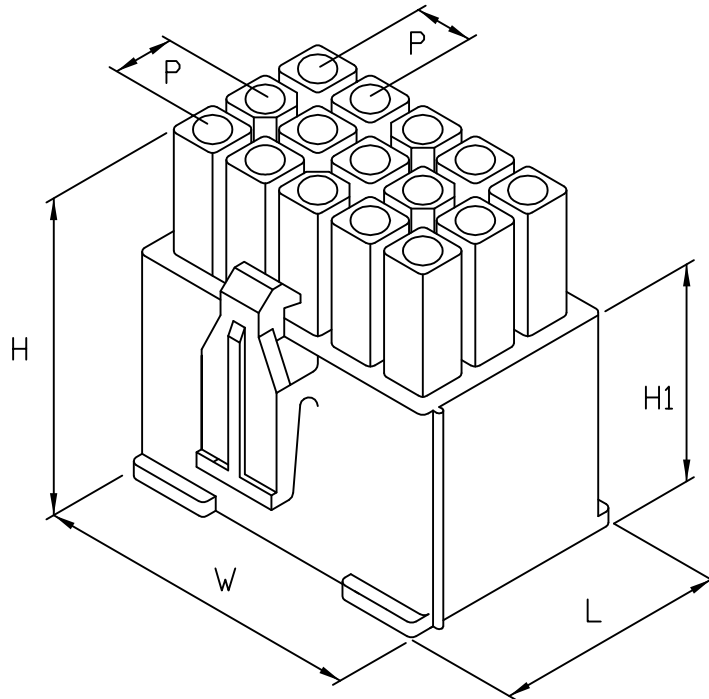

產品編號 Part No: H66A5-15  
 品名 Product: 塑膠母座 - HOUSING  
 材質 Material: Housing: NYLON66 UL94V-2  
 配合端子 Suitable Terminal: T66A5BS  
 配合塑膠 Suitable housing: H66A6  
 額定電壓/電流 Current Rating:  
 AC/DC250V 6A(18~22AWG#)  
 絕緣阻抗 INS. Resistance: 1000M  $\Omega$  Min.  
 耐電壓 Withstand Voltage: 1500V AC/1minute.  
 適用溫度 Operation Temp: -25°C~+85°C  
 顏色 Colour: 本色 (Natural)

DIMENSION:(MM)

P:4.14  $\pm$  0.1  
 L:16.2  $\pm$  0.3  
 W:22.6  $\pm$  0.3  
 H:24.2  $\pm$  0.3  
 H1:14.5  $\pm$  0.2

\* 本成品圖僅供參考,若需做為承認用請聯絡就近業務員確認  
 (The drawing is for reference only,  
 please contact the sales division nearby for final confirmation if it's for approval purpose.)

H/Q: Kaohsiung, Taiwan  
 總公司: 高雄, 台灣  
 TEL: 886-7-6223787  
 FAX: 886-7-6210385  
 E-mail: jmt6317@jmt.com.tw

Taipei Branch, Taiwan  
 台北營業所  
 TEL: 886-2-26940195-7  
 FAX: 886-2-26940738  
 E-mail: taipei.jmt@msa.hinet.net

Overseas, Taiwan  
 外銷業務部  
 TEL: 886-7-6223787  
 FAX: 886-7-6210385  
 E-mail: jmt6318@yahoo.com.tw